



Budapest University of Technology and Economics

Department of Strength of Materials and Structures

English courses

Reinforced Concrete Structures

Code: BMETKEPB603

Lecture no. 1:

# **Introduction, concrete and steel, reinforced concrete (r.c.)**

# Introduction, ways of communication

Lecturer: Dr András Draskóczy

Practical teacher: Bernát Csuka

Topics schedule and requirements and lectures will be available on the home page of the Department: [www.szt.bme.hu](http://www.szt.bme.hu)

To get to informations of the subject, choose: English, Download, English courses, Reinforced Concrete

Weekly reception hours will be communicated on the home page and at the entrance of the Department (K261)

Use of Reinforced Concrete Design Aids is indispensable on the practical lessons, it is available in the copying room of the Department. Recommended text books are listed on the topics schedule.

1st lecture:

## **Introduction, concrete and steel, reinforced concrete (r.c.)**

Content:

1. Brief history of (r.)c. construction
2. Co-action of concrete and steel in r.c.
3. Characteristics and basic mechanical behaviour of concrete and steel
4. Anchorage of steel bars in reinforced concrete
5. Requirements to be satisfied by design
6. Method of design

# 1. Brief history of (r.)c. construction

Roman times: ground stone + good quality mortar with hydraulic bound was used for the construction of the 43 m diameter dome of the Pantheon in Rome 200 BC.

It was forgotten in medieval times

1796: roman cement was first used in England

separate use of concrete and iron till beginning of XIXth century

1824: Aspdin (England) portlan cement

1848, France: Lambot: r.c. ship body

1850, USA: a lawyer named Hyatt submitted a patent for r.c. beams, using links and longitudinal bars

1867, France, Monnier: flower pots, tubes, patent for slabs, stairs

1870: Hennebique (France): r.c. floor constructions

1887: Koenen designed r.c. beams

Rr.c. structural systems, smaller bridges at the end of XIXth century

Beginning of the XXth century: Mörsch (Germany) elaborated the complete theory, used truss model for shear design (will be shown later)

Elaboration of national standards at 1st decade of XXth century: Switzerland (1903), Hungary (1909)

1920-ies: Freyssinet (France) introduced the prestressing technology

Became the most important structural material from the 1930-ies.

1951, Menyhard (Hungary): first use of plasticity theory in national standard

Developments in the 20th century in:

- concrete technology

- steel products (high strength steel)

- prefabrication

- monolithic construction with industrialized methods

- thin wall r.c. constr., shells

- mass production of prestressed r.c. members .

- design theory (use of probability principles, limit state

design theory)



Reinforced Concrete 2012

lecture 1/6

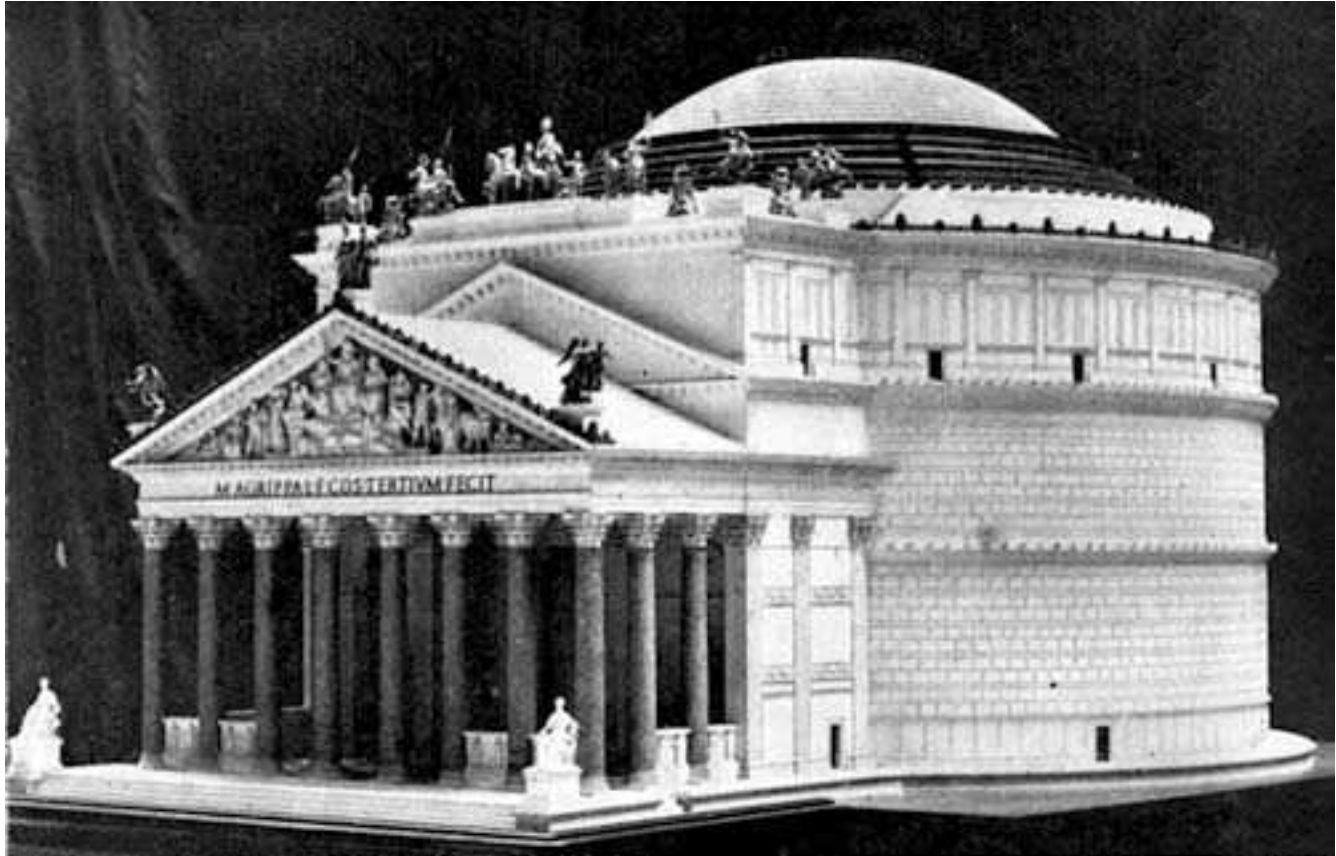

Reinforced Concrete 2012

lecture 1/7

## 2. Co-action of concrete and steel in r.c.

### Advantages

- same coefficient of thermal expansion ( $\alpha_t = 1E-5 \text{ 1/}^\circ\text{C}$ )
- concrete prevents buckling of slender steel bars
- concrete improves fire-resistance
- concrete protects steel from corrosion



### 3. Characteristics and basic mechanical behaviour of concrete and steel

#### -Concrete:

composition: cement (cca 300kg)+ aggregate(cca 1,2m<sup>3</sup>) + water(cca 150 l)  $\approx$  1 m<sup>3</sup> fresh concrete

$\sigma$ - $\epsilon$  relationships of concrete:

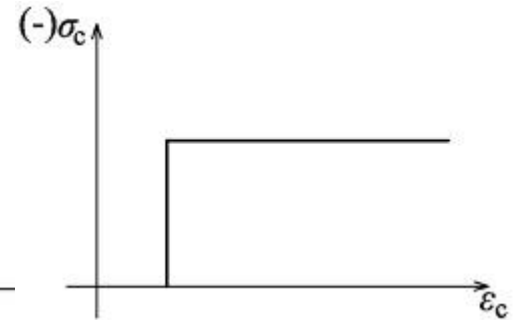
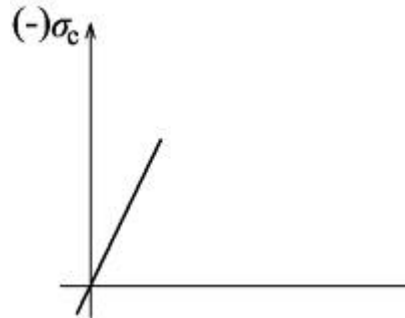
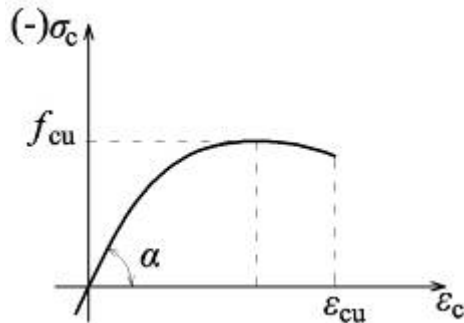

uniaxial tension and compression test - idealized diagrams

uncracked and cracked state      polastic state

## Compression tests of concrete specimens failure of concrete by crushing

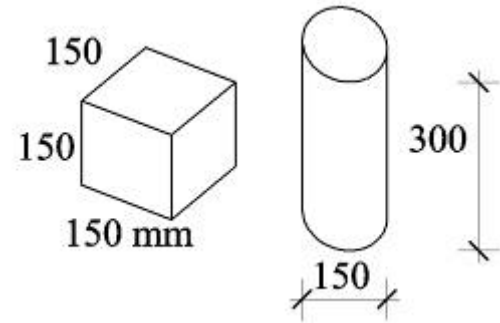
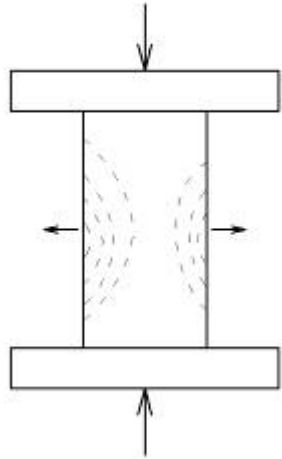

cube strength and cylinder strength

characteristic strength ( $f_{ck}$ ) and design strength ( $f_{cd}$ ), safety factor:

$$f_{cd} = f_{ck} / \gamma_C \quad \gamma_C = 1,5$$

compressive strength  $\approx 10 \times$  tensile strength

strength under biaxial loading

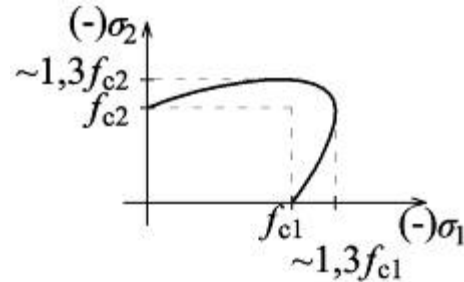

shear strength:

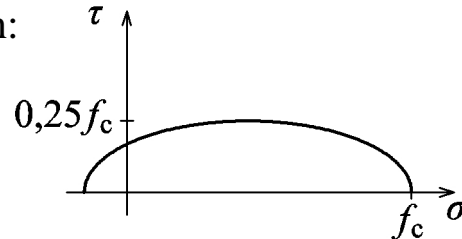

Concrete grades, *designation of concrete*: C16/20-XC0-32-F2

C: concrete 16: cylinder compr. Strength ( $\text{N}=\text{mm}^2$ ) 20: cube strengt  
32: max.diam. of aggregate F2: stands for consistency (moderately plastic)

placing of fresh concrete (danger of desintegration, importance of vibration)

curing of fresh concrete (keep wet during the first week!)

linear coeff. of thermal expansion:  $\alpha_t = 1E-5$

modulus of elasticity and deformational modulus of concrete

$$E_c = \frac{E_{co}}{1 + \phi_{cr}}$$

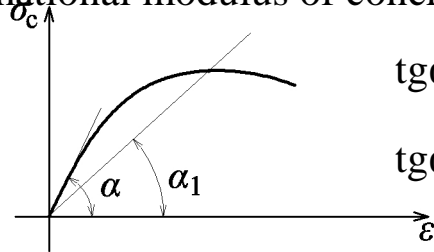

$$\text{tg}\alpha = E_{co}$$

$$\text{tg}\alpha_1 = E_c$$

*creep of concrete*: long term deformation under constant compression stress (moving of water towards the surface),

*creep coefficient*  $\phi_{cr} = \frac{\epsilon_{pl}}{\epsilon_{el}} \approx 1,5 \text{ to } 2,5$

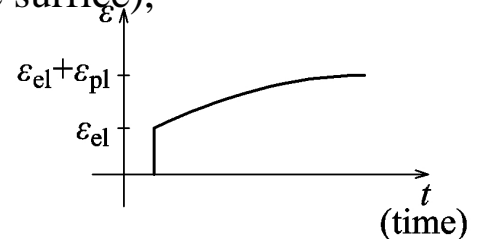

depends from: concrete grade, age, stress level, effective thickness, rel. humidity of the air, duration of loading

*shrinkage of concrete*: loss of volume of the concrete due to drying,  
independent from stresses  
consequences of shrinkage: compression in steel bars, shrinkage  
cracks the more reinforcement, the greater danger of cracking)  
final deformation due to shrinkage:  
depends from: age of concrete, relative humidity of the air,  
effective thickness

## Reinforcing steel

mechanical behaviour

Modulus of elasticity:

$$E_s = \text{tg}\alpha$$

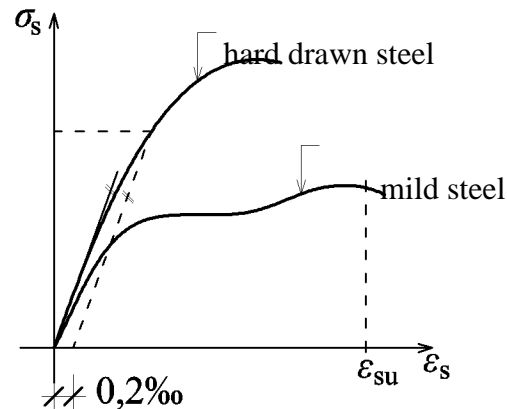

$\sigma$ - $\epsilon$  relationship of mild steel and hard drawn steel

*Types of reinforcing steel:* mild steel (hot rolled steel)  
hard drawn steel, high strength steel

*Designation of steel products:* B38.24 yield limit (N/mm<sup>2</sup>)  
concrete rupture strength (N/mm<sup>2</sup>)

*Design strength:*  $f_{yd} = f_{yk} / \gamma_s$   $\gamma_s = 1,15$  safety factor

*Products:* 12 m long straight bars, rolls up to 8 mm diameter

Spot-welded meshes (fabrics)

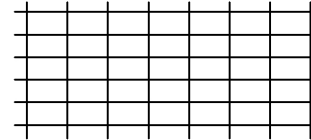

ladders

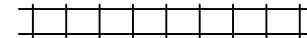

*Diameters:*  $\phi 6, 8, 10, 12, \dots, 40$

cages

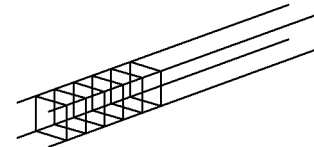

Jointing of bars by pressed sleeves

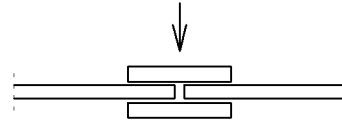

by resistance spot-welding:

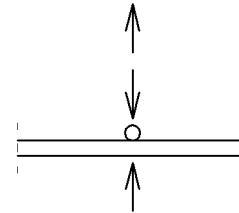

by arc-welding with tie:

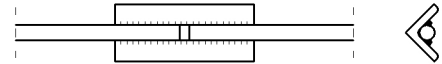

#### 4. Anchorage of steel bars in reinforced concrete

surface pattern of bars: smooth and deformed bars

twisted ribs:



arrow ribs:



bound stresses, bound coefficients smooth surface:  $\alpha_b=1$

deformed surface:  $\alpha_b=2$

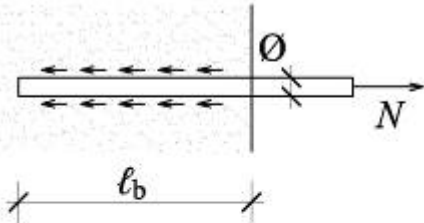

$$= \phi^2 \pi \frac{1}{4} f_{yd} = \phi \pi \alpha_b f_{ctd} l_b \rightarrow l_b = \frac{f_{yd} \phi}{4 \alpha_b f_{ct,d}}$$

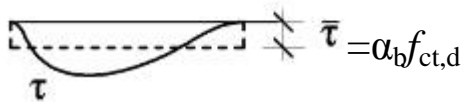

The necessity of bound:

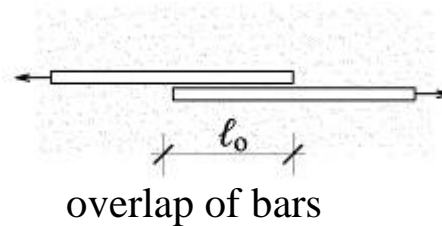
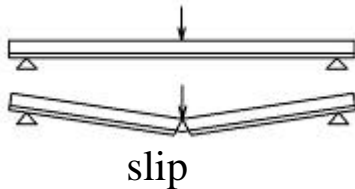

overlap of bars

pull-out test: determination of the anchorage length ( $l_b$ )



Reduction of the anchorage length by application of 90 degree bent and of hoop:

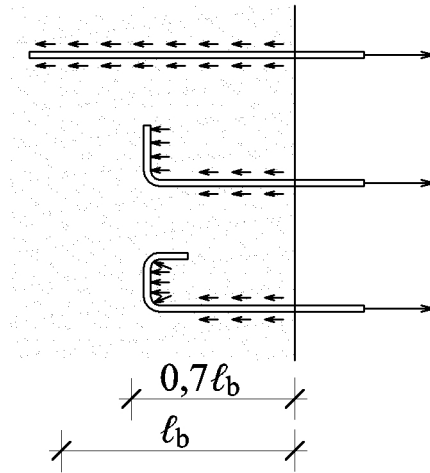

## 5. Requirements to be satisfied by design

-loadbearing capacity:

equilibrium between internal forces provoked by loads and effects  
and resistance forces of cross-sections

loss of stability (buckling, overturning, sliding)

-rigidity

-crack control (aesthetics, functionality, corrosion)

-durability (fatigue failure)

-fire-resistance

-technological, functional, aesthetical requirements

-economy in complex meaning (of design, construction, use and  
demolishment)

## 6. Method of design

design data

- actions, loads

- subsoil conditions

- choice of adequate technology

preliminary project

- importance of cooperation between architect and structural engineer

building permission project

- static model and calculations

- choice of structural material

- investigation of variants

- economical evaluation

working drawings (execution project, detailed drawings)

- consultations with the constructor

- part of the documentation: drawings, lists of bars

- technical description

bill of quantities  
list of works  
technological project (in special cases)